

Panel mounted socket - Part no. 1155A



- screw terminals
- SoftCONTACT
- 20° inclination
- Products with pilot contacts: Part no. + index P

Protection type	IP 44
Ampere	63A
Poles	5p
Voltage	400V
Hertz	50-60 Hz
Earth position	6h
Contact	standard
Connection technology	Screw terminals

Std. Pack. 5 Qty.

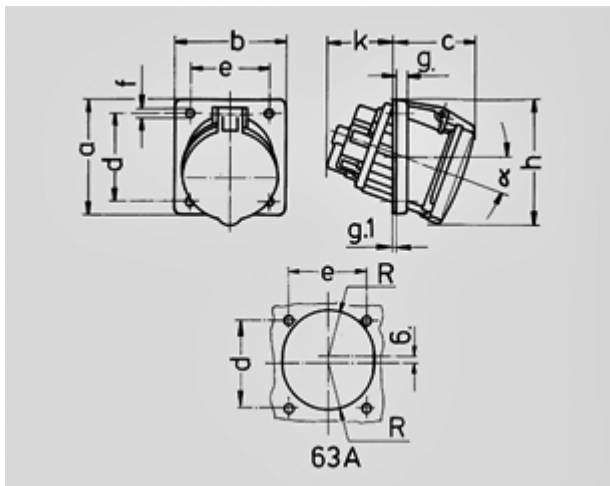

Drawing	Amp.	63		
		Poles		
1 MB 297		3	4	5
Dim. in mm	a	110	110	110
	b	106	106	106
	c	85	85	85
	d	85	85	85
	e	77	77	77
	f	6,2	6,2	6,2
	g.	12	12	12
	g.1	2	2	2
	h	122	122	122
	k	69	69	69
	R	46	46	46
	alpha	20°	20°	20°
Terminal for cond. cross section (mm²) min.-max.		6	6	6
		-25	-25	-25